

Dimensions and materials
Dimensioni e materiali

Description and advantages
Descrizione e vantaggi

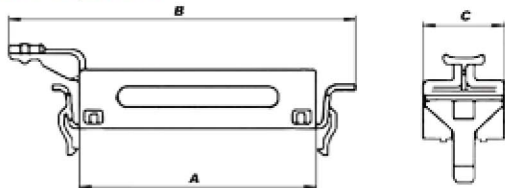

Top support
Supporto superiore



Size Grandezza	A	B	C
6B «44x27»	57	113,3	40
10B «57x27»	70	126	40
16B «77x27»	90,6	146,3	40
24B «104x27»	117	173	40

Complete support composed by 1 top support and 1 base support.
Supporto completo composto da 1 supporto superiore e 1 inferiore.

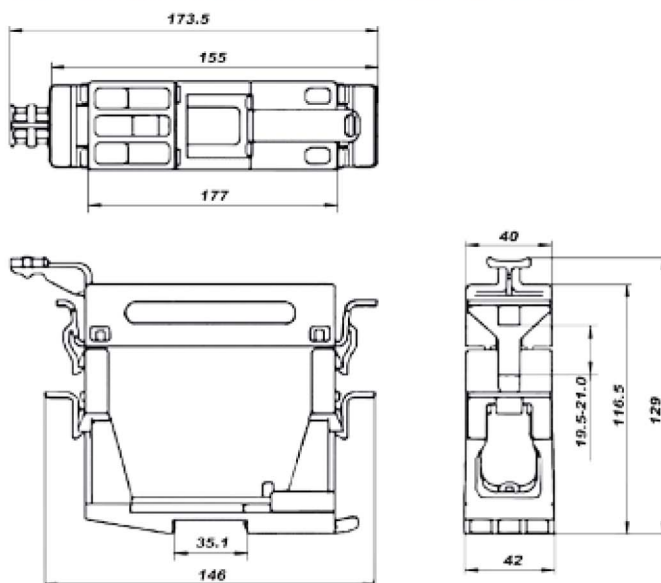

This mounting rail system allows you to mount the multipolar connectors inserts on the rail inside the control cabinets.

- No tools are needed and contact inserts are simply snapped in place as well as the support on the rail.
- Labelling surfaces on the product allow for clear equipment identification.
- For assembling on rail 35x7,5 and 35x15 in accordance with DIN EN60715.
- The support enables users to arrange a maximum number of connections in a minimum area within the control cabinet.
- Quick locking of the male with female inserts through levers.
- Fully compatible: it allows to accept inserts with same sizes not manufactured by Westec.
- The inserts can be assembled also with code pins (see page 16.01)

Questo sistema di supporto permette di montare gli inserti dei connettori multipolari sulle guide all'interno dei quadri di controllo.

- *Non sono necessari utensili sia per il montaggio degli inserti sul supporto che lo stesso sulla guida.*
- *Ampie zone per l'etichettatura e l'identificazione.*
- *Per l'assemblaggio su guide 35x7,5 e 35x15 secondo la norma DIN EN60715.*
- *Le ridotte dimensioni dei supporti consentono di massimizzare il numero delle connessioni all'interno del quadro di controllo.*
- *Gli inserti maschio/femmina sono uniti tramite un sistema rapido di aggancio costituito da 2 leve.*
- *Completamente compatibile: il supporto consente di montare altri inserti, aventi le stesse grandezze, non prodotti da Westec.*
- *Gli inserti possono essere assemblati anche con perni di codifica (Vedi pag. 16.01)*

Application: For all inserts, size:
 Applicazioni: Per tutti gli inserti, grandezze:

- 6B «44x27»
- 10B «57x27»
- 16B «77x27»
- 24B «104x27»

For inserts series: S-D, S-DD, S-E, S-EE, S-EHV, S-ES,
 Per inserti serie: S-ESHV, S-HSB, S-K, S-M

Material - Materiale: Polycarbonate - Policarbonato

Flammability - Autoestingenza: UL-94 V0



Top support assembly
Assemblaggio del supporto superiore

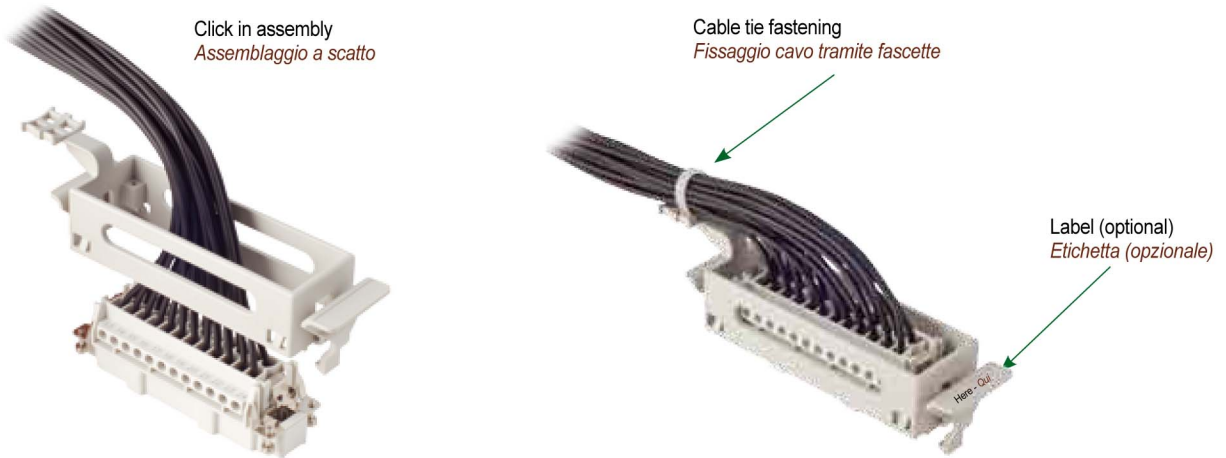

Base support assembly
Assemblaggio del supporto inferiore

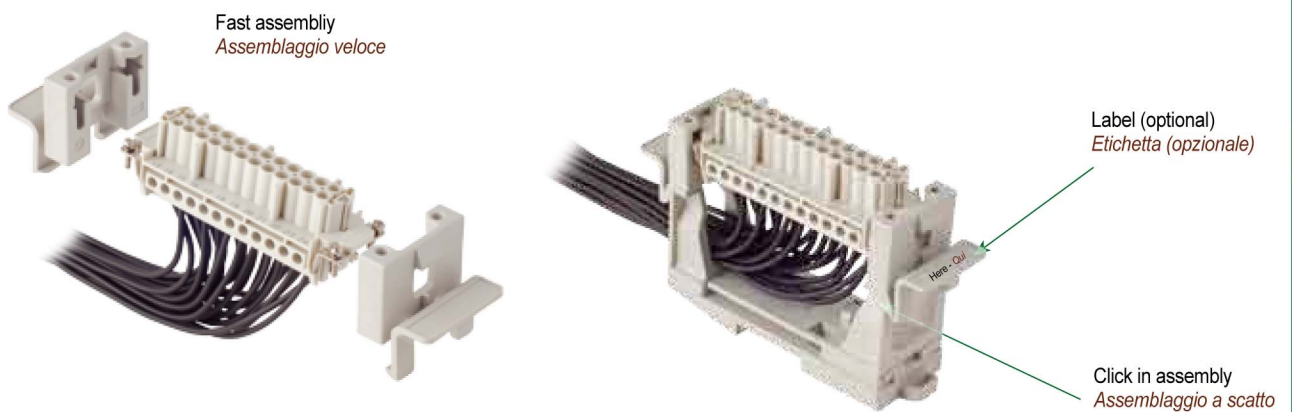

Complete set assembly
Assemblaggio del supporto completo

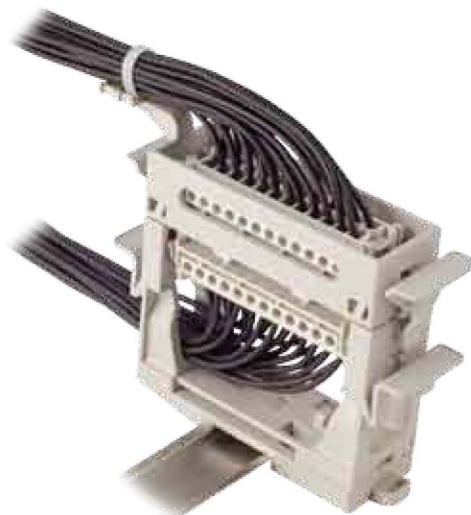

ACC

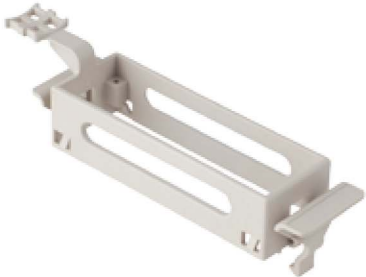
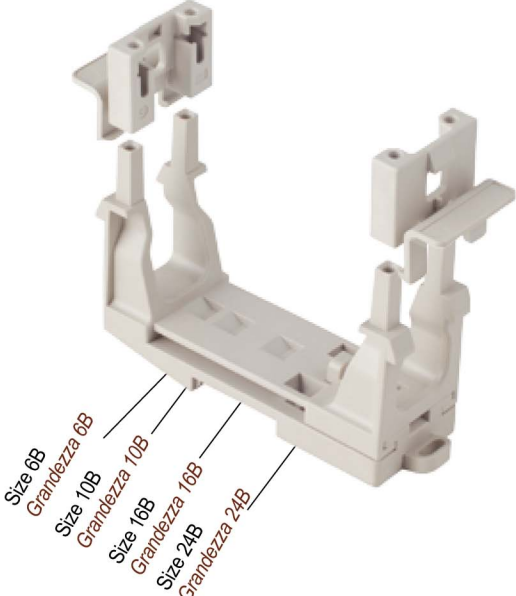
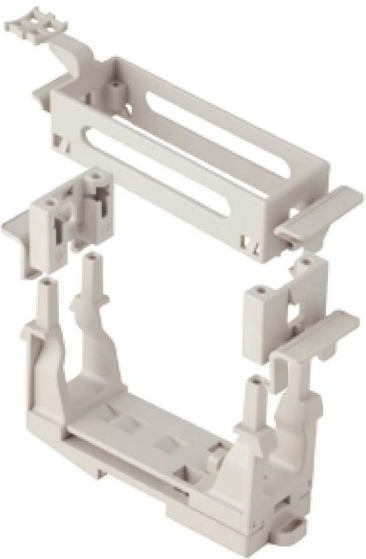
<p>Top support <i>Supporto superiore</i></p>	<p>Description <i>Descrizione</i></p>	<p>Part No. <i>Codice</i></p>
	<p>Top support for inserts size 6B «44x27» <i>Supporto superiore per inserti grandezza 6B«44x27»</i></p> <p>Top support for inserts size 10B «57x27» <i>Supporto superiore per inserti grandezza 10B«57x27»</i></p> <p>Top support for inserts size 16B «77x27» <i>Supporto superiore per inserti grandezza 16B«77x27»</i></p> <p>Top support for inserts size 24B «104x27» <i>Supporto superiore per inserti grandezza 24B«104x27»</i></p> <p>Removal tools for inserts (see section 60) <i>Utensile estrattore per inserti (vedere sezione 60)</i></p>	<p>7006.7000.0</p> <p>7010.7000.0</p> <p>7016.7000.0</p> <p>7024.7000.0</p> <p>8500.7912.0</p>
<p>Base support <i>Supporto inferiore</i></p>		
 <p>Size 6B <i>Grandezza 6B</i></p> <p>Size 10B <i>Grandezza 10B</i></p> <p>Size 16B <i>Grandezza 16B</i></p> <p>Size 24B <i>Grandezza 24B</i></p>	<p>Base support plate for inserts size 6B, 10B, 16B, 24B <i>Supporto inferiore per inserti grandezza 6B, 10B, 16B, 24B</i></p>	<p>7000.7000.0</p>
<p>Complete support composed by 1 top support and 1 base support. <i>Supporto completo composto da 1 supporto superiore e 1 inferiore.</i></p>		
	<p>Complete set for 6B «44x27» inserts <i>Kit completo per inserti grandezza 6B«44x27»</i></p> <p>Complete set for 10B «57x27» inserts <i>Kit completo per inserti grandezza 10B«57x27»</i></p> <p>Complete set for 16B «77x27» inserts <i>Kit completo per inserti grandezza 16B«77x27»</i></p> <p>Complete set for 24B «104x27» inserts <i>Kit completo per inserti grandezza 24B«104x27»</i></p> <p>Removal tools for inserts (see section 60) <i>Utensile estrattore per inserti (vedere sezione 60)</i></p> <p>For inserts / <i>Per inserti</i> Series: S-D, S-DD, S-E, S-EE, S-EHV, S-ESHV, S-HSB, S-K</p>	<p>7006.7009.0</p> <p>7010.7009.0</p> <p>7016.7009.0</p> <p>7024.7009.0</p> <p>8500.7912.0</p>

ACC

APPLICATION WITH “CODE PINS”



INSERT A

INSERT B

INSERT C

INSERT D

RIGHT COUPLING :

A with B and C with D

COUPLING NOT POSSIBLE:

A with D and C with B