

STT500

Thyristor-Thyristor Modules

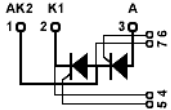
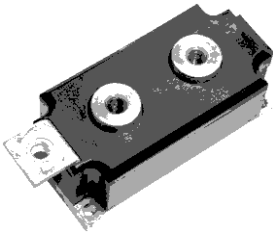

Type	V_{RSM} V_{DSM} V	V_{RRM} V_{DRM} V
STT500GK08	900	800
STT500GK12	1300	1200
STT500GK14	1500	1400
STT500GK16	1700	1600
STT500GK18	1900	1800

Dimensions in mm (1mm=0.0394")

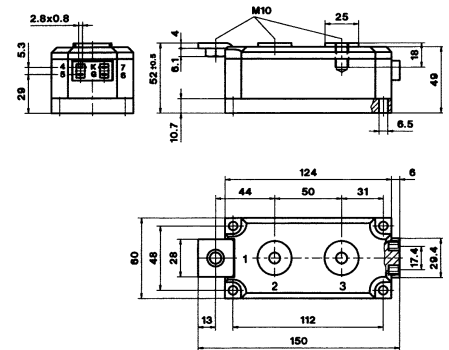

Symbol	Test Conditions	Maximum Ratings	Unit	
I_{TRMS}, I_{FRMS} I_{TAVM}, I_{FAVM}	$T_{VJ}=T_{VJM}$ $T_C=85^{\circ}C; 180^{\circ}$ sine	785 500	A	
I_{TSM}, I_{FSM}	$T_{VJ}=45^{\circ}C$ $V_R=0$ $t=10ms$ (50Hz), sine $t=8.3ms$ (60Hz), sine	15000 16000	A	
	$T_{VJ}=T_{VJM}$ $V_R=0$ $t=10ms$ (50Hz), sine $t=8.3ms$ (60Hz), sine	13000 14400		
$\int i^2 dt$	$T_{VJ}=45^{\circ}C$ $V_R=0$ $t=10ms$ (50Hz), sine $t=8.3ms$ (60Hz), sine	1125000 1062000	A ² s	
	$T_{VJ}=T_{VJM}$ $V_R=0$ $t=10ms$ (50Hz), sine $t=8.3ms$ (60Hz), sine	845000 813000		
$(di/dt)_{cr}$	$T_{VJ}=T_{VJM}$ $f=50Hz, t_p=200\mu s$ $V_D=2/3V_{DRM}$ $I_G=1A$ $di_G/dt=1A/\mu s$	repetitive, $I_T=960A$ non repetitive, $I_T=I_{TAVM}$	100 500	A/ μs
	$T_{VJ}=T_{VJM};$ $R_{GK}=\infty;$ method 1 (linear voltage rise)	$V_{DR}=2/3V_{DRM}$	1000	V/ μs
P_{GM}	$T_{VJ}=T_{VJM}$ $I_T=I_{TAVM}$	$t_p=30\mu s$ $t_p=500\mu s$	120 60	W
P_{GAV}			20	W
V_{RGM}			10	V
T_{VJ} T_{VJM} T_{stg}			-40...+140 140 -40...+125	$^{\circ}C$
V_{ISOL}	50/60Hz, RMS $I_{ISOL} \leq 1mA$	$t=1min$ $t=1s$	3000 3600	V~
M_d	Mounting torque (M6) Terminal connection torque (M8)		4.5-7/40-60 11-13/97-115	Nm/lb.in.
Weight	Typical including screws		940	g

STT500

Thyristor-Thyristor Modules

Symbol	Test Conditions	Characteristic Values	Unit
IRRM	$T_{VJ}=T_{VJM}; V_R=V_{RRM}$	40	mA
V_T	$I_T=1200A; T_{VJ}=25^{\circ}C$	1.3	V
V_{TO}	For power-loss calculations only ($T_{VJ}=T_{VJM}$)	0.8	V
r_T		0.38	mΩ
V_{GT}	$V_D=6V;$ $T_{VJ}=25^{\circ}C$ $T_{VJ}=-40^{\circ}C$	2 3	V
I_{GT}	$V_D=6V;$ $T_{VJ}=25^{\circ}C$ $T_{VJ}=-40^{\circ}C$	300 400	mA
V_{GD}	$T_{VJ}=T_{VJM};$ $V_D=2/3V_{DRM}$	0.25	V
I_{GD}	$T_{VJ}=T_{VJM};$ $V_D=2/3V_{DRM}$	10	mA
I_L	$T_{VJ}=25^{\circ}C; t_p=30\mu s; V_D=6V$ $I_G=1A; di_g/dt=1A/\mu s$	400	mA
I_H	$T_{VJ}=25^{\circ}C; V_D=6V; R_{GK}=\infty$	300	mA
t_{gd}	$T_{VJ}=25^{\circ}C; V_D=1/2V_{DRM}$ $I_G=1A; di_g/dt=1A/\mu s$	2	us
t_q	$T_{VJ}=T_{VJM}; I_T=500A; t_p=200\mu s; -di/dt=10A/\mu s$ $V_R=100V; dv/dt=50V/\mu s; V_D=2/3V_{DRM}$	350	us
R_{thJC}	DC current	0.072	K/W
R_{thJK}	DC current	0.096	K/W
ds	Creeping distance on surface	12.7	mm
da	Creepage distance in air	9.6	mm
a	Maximum allowable acceleration	50	m/s ²

FEATURES

- * International standard package
- * Direct copper bonded Al₂O₃-ceramic with copper base plate
- * Planar passivated chips
- * Isolation voltage 3600 V~

APPLICATIONS

- * Motor control, softstarter
- * Power converter
- * Heat and temperature control for industrial furnaces and chemical processes
- * Lighting control
- * Solid state switches

ADVANTAGES

- * Simple mounting
- * Improved temperature and power cycling
- * Reduced protection circuits

STT500

Thyristor-Thyristor Modules

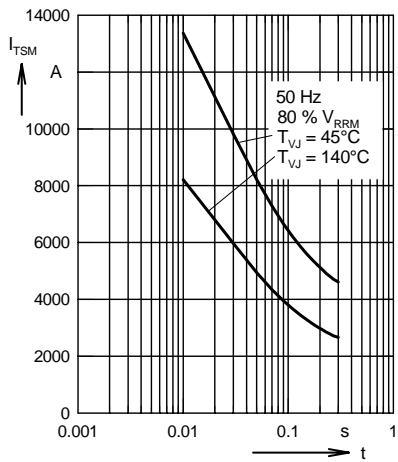

Fig. 1 Surge overload current
 I_{TSM} , I_{FSM} : Crest value, t: duration

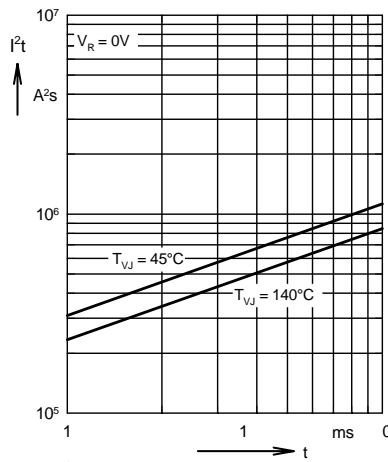

Fig. 2 i^2t versus time (1-10 ms)

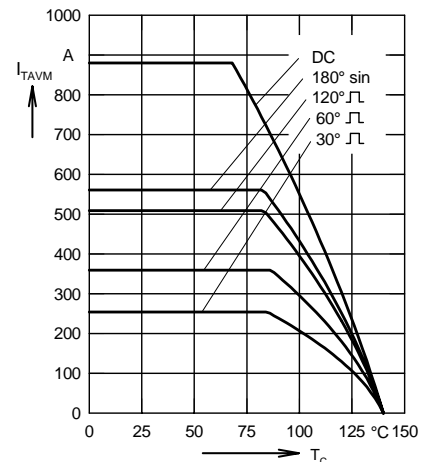

Fig. 3 Maximum forward current at case temperature

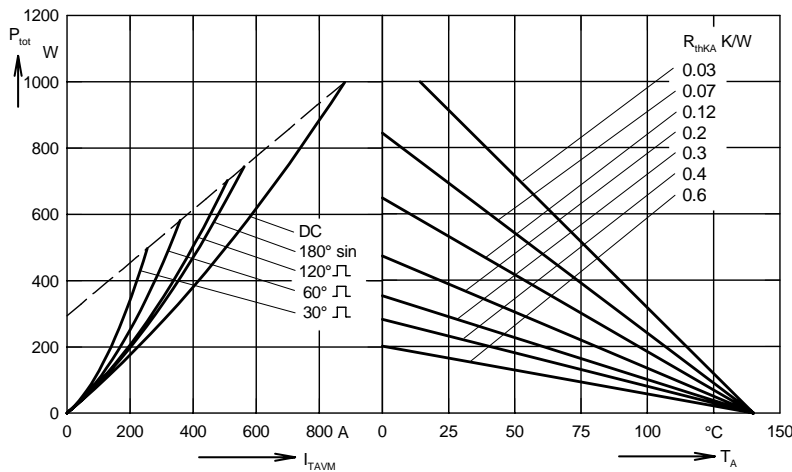

Fig. 4 Power dissipation versus on-state current and ambient temperature

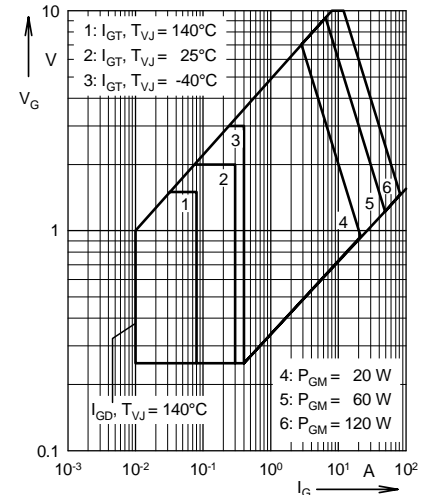

Fig. 5 Gate trigger characteristics

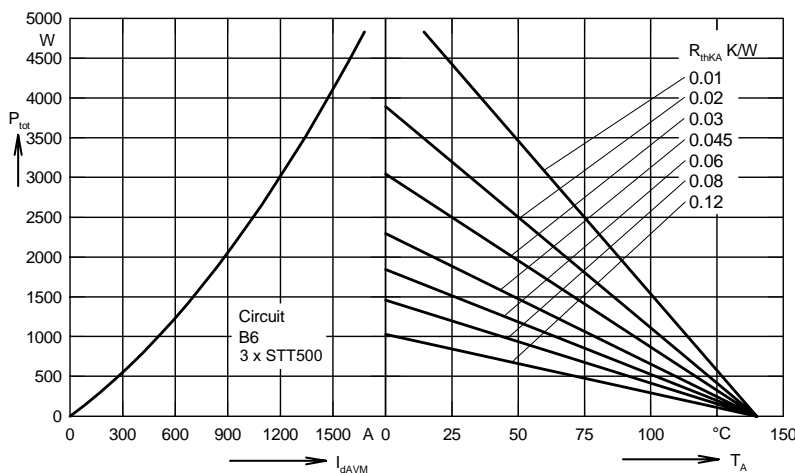

Fig. 6 Three phase rectifier bridge: Power dissipation versus direct output current and ambient temperature

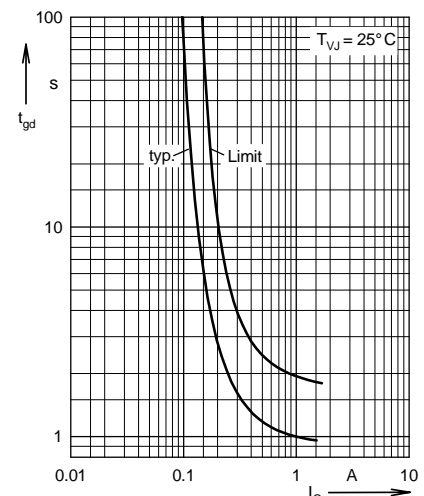

Fig. 7 Gate trigger delay time

STT500

Thyristor-Thyristor Modules

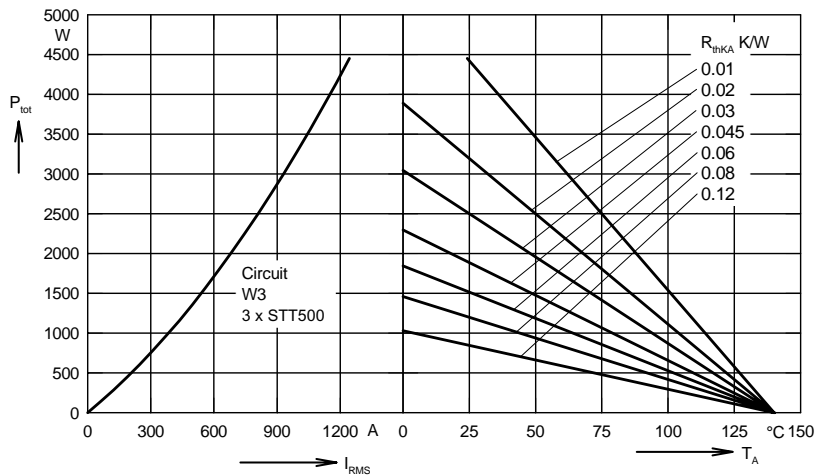

Fig. 8 Three phase AC-controller: Power dissipation versus RMS output current and ambient temperature

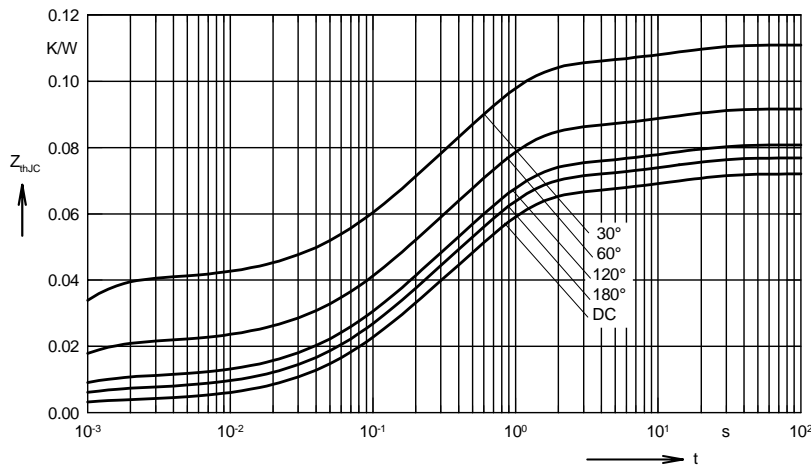

Fig. 9 Transient thermal impedance junction to case (per thyristor)

R_{thJC} for various conduction angles d :

d	R_{thJC} (K/W)
DC	0.072
180°	0.0768
120°	0.081
60°	0.092
30°	0.111

Constants for Z_{thJC} calculation:

i	R_{thi} (K/W)	t_i (s)
1	0.0035	0.0054
2	0.0186	0.098
3	0.0432	0.54
4	0.0067	12

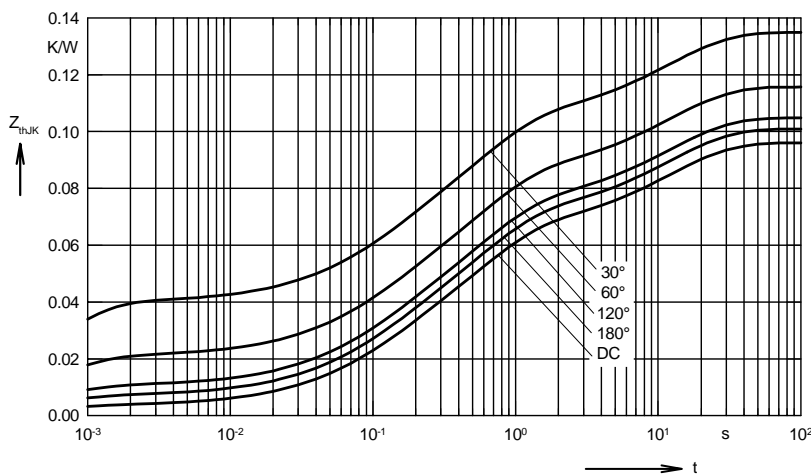

Fig.10 Transient thermal impedance junction to heatsink (per thyristor)

R_{thJK} for various conduction angles d :

d	R_{thJK} (K/W)
DC	0.096
180°	0.1
120°	0.105
60°	0.116
30°	0.135

Constants for Z_{thJK} calculation:

i	R_{thi} (K/W)	t_i (s)
1	0.0035	0.0054
2	0.0186	0.098
3	0.0432	0.54
4	0.0067	12
5	0.024	12