

# STT60

## Thyristor-Thyristor Modules

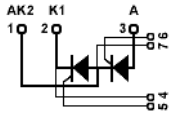
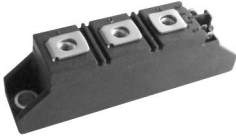

Type	$V_{RSM}$ $V_{DSM}$ V	$V_{RRM}$ $V_{DRM}$ V
STT60GK08	900	800
STT60GK12	1300	1200
STT60GK14	1500	1400
STT60GK16	1700	1600
STT60GK18	1900	1800

Dimensions in mm (1mm=0.0394")

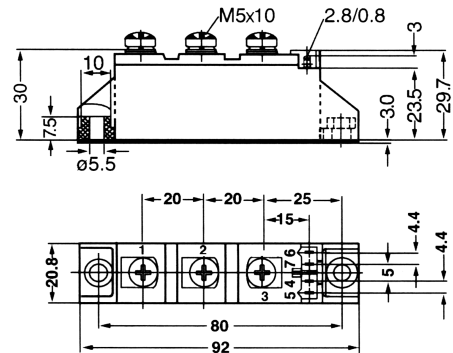

Symbol	Test Conditions	Maximum Ratings	Unit
$I_{TRMS}, I_{FRMS}$ $I_{TAVM}, I_{FAVM}$	$T_{VJ}=T_{VJM}$ $T_C=85^{\circ}C; 180^{\circ}$ sine	100 60	A
$I_{TSM}, I_{FSM}$	$T_{VJ}=45^{\circ}C$ $V_R=0$ $t=10ms$ (50Hz), sine $t=8.3ms$ (60Hz), sine	1500 1600	A
	$T_{VJ}=T_{VJM}$ $V_R=0$ $t=10ms$ (50Hz), sine $t=8.3ms$ (60Hz), sine	1350 1450	
$\int i^2 dt$	$T_{VJ}=45^{\circ}C$ $V_R=0$ $t=10ms$ (50Hz), sine $t=8.3ms$ (60Hz), sine	11200 10750	A <sup>2</sup> s
	$T_{VJ}=T_{VJM}$ $V_R=0$ $t=10ms$ (50Hz), sine $t=8.3ms$ (60Hz), sine	9100 8830	
$(di/dt)_{cr}$	$T_{VJ}=T_{VJM}$ $f=50Hz, t_p=200\mu s$ $V_D=2/3V_{DRM}$ $I_G=0.45A$ $di_G/dt=0.45A/\mu s$	repetitive, $I_T=150A$ 150	A/ $\mu s$
		non repetitive, $I_T=I_{TAVM}$ 500	
$(dv/dt)_{cr}$	$T_{VJ}=T_{VJM};$ $R_{GK}=\infty;$ method 1 (linear voltage rise)	$V_{DR}=2/3V_{DRM}$ 1000	V/ $\mu s$
$P_{GM}$	$T_{VJ}=T_{VJM}$ $I_T=I_{TAVM}$	$t_p=30\mu s$ $t_p=300\mu s$	10 5 W
$P_{GAV}$			0.5 W
$V_{RGM}$			10 V
$T_{VJ}$ $T_{VJM}$ $T_{stg}$			-40...+125 125 -40...+125 $^{\circ}C$
$V_{ISOL}$	50/60Hz, RMS $I_{ISOL} \leq 1mA$	$t=1min$ $t=1s$	3000 3600 V~
$M_d$	Mounting torque (M5) Terminal connection torque (M5)		2.5-4.0/22-35 2.5-4.0/22-35 Nm/lb.in.
Weight	Typical including screws		90 g

# STT60

## Thyristor-Thyristor Modules

Symbol	Test Conditions	Characteristic Values	Unit
$I_{RRM}, I_{DRM}$	$T_{VJ}=T_{VJM}; V_R=V_{RRM}; V_D=V_{DRM}$	5	mA
$V_T, V_F$	$I_T, I_F=200A; T_{VJ}=25^{\circ}C$	1.57	V
$V_{TO}$	For power-loss calculations only ( $T_{VJ}=125^{\circ}C$ )	0.85	V
$r_T$		3.7	$m\Omega$
$V_{GT}$	$V_D=6V;$ $T_{VJ}=25^{\circ}C$ $T_{VJ}=-40^{\circ}C$	1.5 1.6	V
$I_{GT}$	$V_D=6V;$ $T_{VJ}=25^{\circ}C$ $T_{VJ}=-40^{\circ}C$	100 200	mA
$V_{GD}$	$T_{VJ}=T_{VJM}; V_D=2/3V_{DRM}$	0.2	V
$I_{GD}$		10	mA
$I_L$	$T_{VJ}=25^{\circ}C; t_p=10\mu s; V_D=6V$ $I_G=0.45A; di_G/dt=0.45A/\mu s$	450	mA
$I_H$	$T_{VJ}=25^{\circ}C; V_D=6V; R_{GK}=\infty$	200	mA
$t_{gd}$	$T_{VJ}=25^{\circ}C; V_D=1/2V_{DRM}$ $I_G=0.45A; di_G/dt=0.45A/\mu s$	2	$\mu s$
$t_q$	$T_{VJ}=T_{VJM}; I_T=150A; t_p=200\mu s; -di/dt=10A/\mu s$ $V_R=100V; dv/dt=20V/\mu s; V_D=2/3V_{DRM}$	150	$\mu s$
$Q_S$	$T_{VJ}=T_{VJM}; I_T, I_F=50A; -di/dt=3A/\mu s$	100	$\mu C$
$I_{RM}$		24	A
$R_{thJC}$	per thyristor/diode; DC current per module	0.45 0.225	K/W
$R_{thJK}$	per thyristor/diode; DC current per module	0.65 0.325	K/W
$d_s$	Creeping distance on surface	12.7	mm
$d_A$	Strike distance through air	9.6	mm
$a$	Maximum allowable acceleration	50	$m/s^2$

### FEATURES

- \* International standard package
- \* Copper base plate
- \* Planar passivated chips
- \* Isolation voltage 3600 V~

### APPLICATIONS

- \* DC motor control
- \* Softstart AC motor controller
- \* Light, heat and temperature control

### ADVANTAGES

- \* Space and weight savings
- \* Simple mounting with two screws
- \* Improved temperature and power cycling
- \* Reduced protection circuits

# STT60

## Thyristor-Thyristor Modules

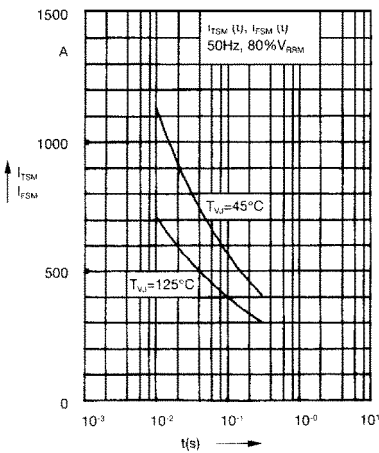

Fig. 1 Surge overload current  
 $I_{TSM}$ ,  $I_{FSM}$ : Crest value,  $t$ : duration

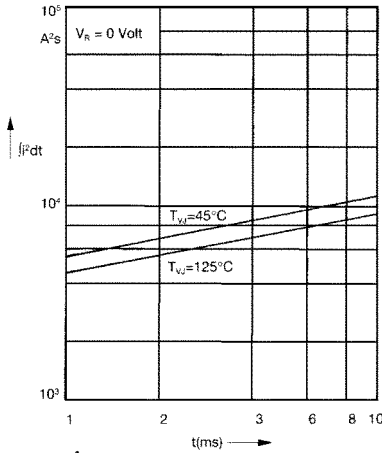

Fig. 2  $\int i^2 dt$  versus time (1-10 ms)

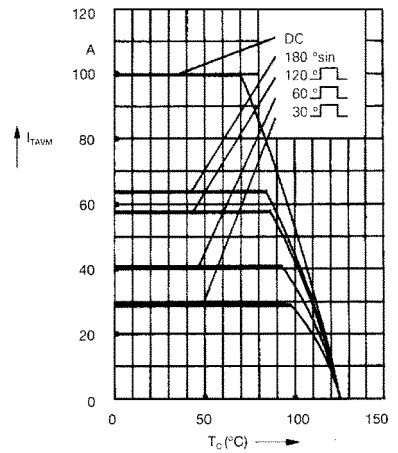

Fig. 2a Maximum forward current at case temperature

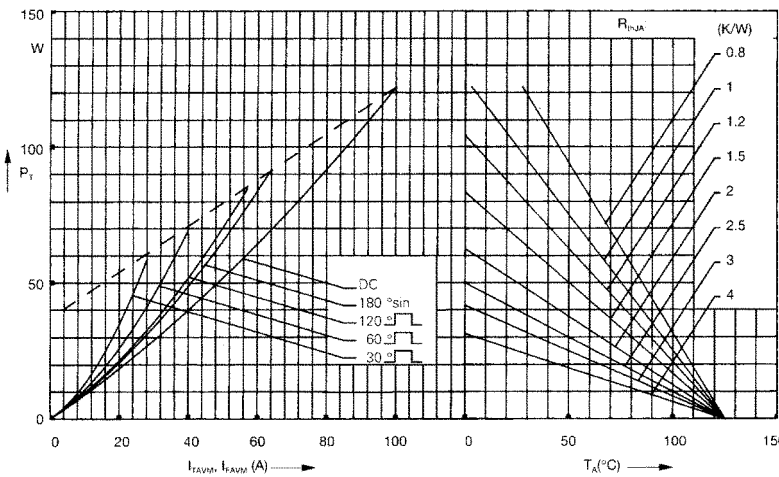

Fig. 3 Power dissipation versus on-state current and ambient temperature (per thyristor or diode)

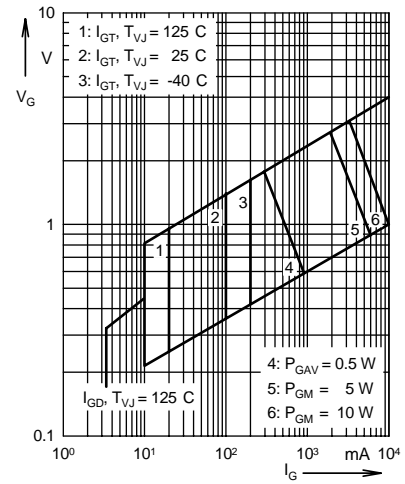

Fig. 4 Gate trigger characteristics

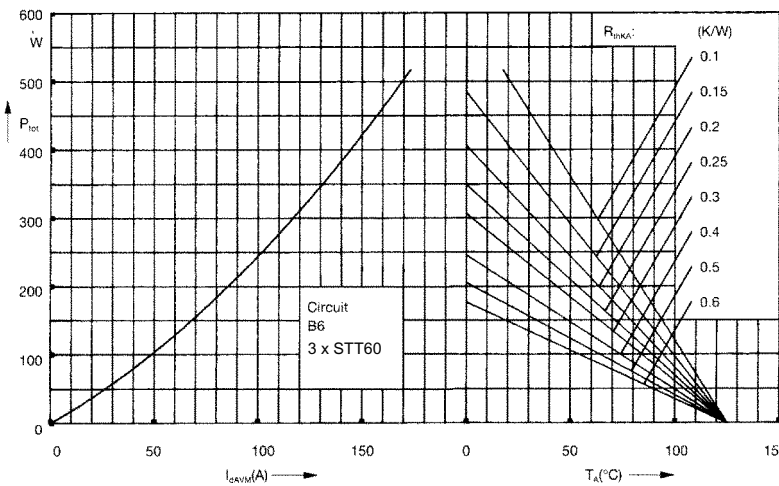

Fig. 5 Three phase rectifier bridge: Power dissipation versus direct output current and ambient temperature

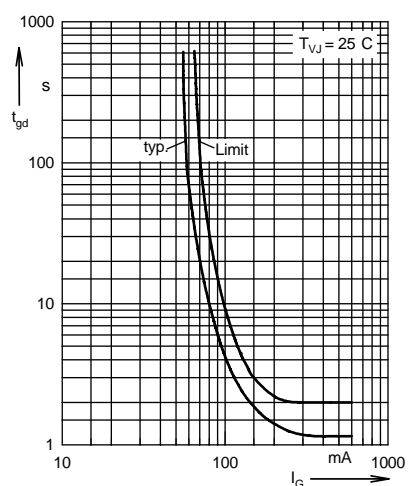

Fig. 6 Gate trigger delay time

# STT60

## Thyristor-Thyristor Modules

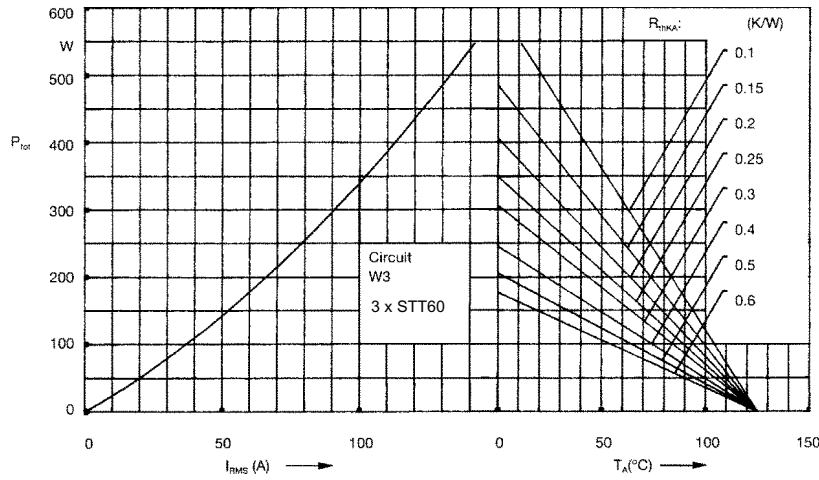

Fig. 7 Three phase AC-controller: Power dissipation versus RMS output current and ambient temperature

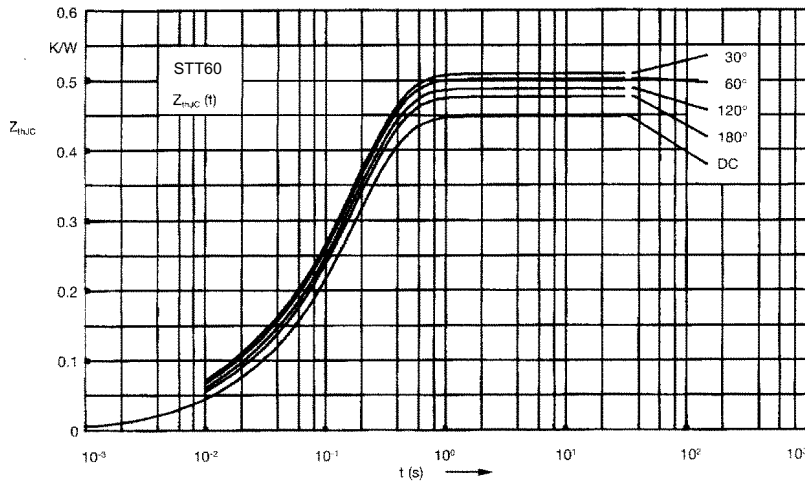

Fig. 8 Transient thermal impedance junction to case (per thyristor or diode)

$R_{thJC}$  for various conduction angles d:

d	$R_{thJC}$ (K/W)
DC	0.45
180°C	0.47
120°C	0.49
60°C	0.505
30°C	0.52

Constants for  $Z_{thJC}$  calculation:

i	$R_{thi}$ (K/W)	$t_i$ (s)
1	0.014	0.015
2	0.026	0.0095
3	0.41	0.175

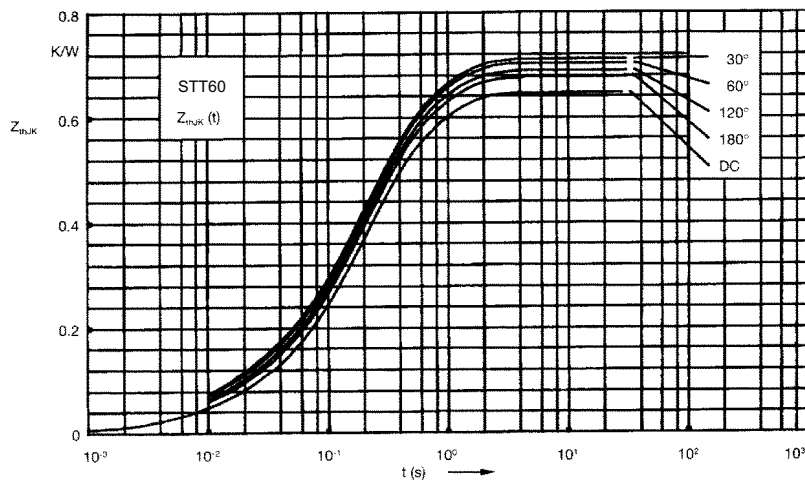

Fig. 9 Transient thermal impedance junction to heatsink (per thyristor or diode)

$R_{thJK}$  for various conduction angles d:

d	$R_{thJK}$ (K/W)
DC	0.65
180°C	0.67
120°C	0.69
60°C	0.705
30°C	0.72

Constants for  $Z_{thJK}$  calculation:

i	$R_{thi}$ (K/W)	$t_i$ (s)
1	0.014	0.015
2	0.026	0.0095
3	0.41	0.175
4	0.2	0.67